











**Example: Single Functions**

-  Emergency stop
-  Safety door
-  Controlled stopping
-  Monitoring BWS type 4
-  Monitoring BWS type 2 with testing
-  Testable PDF sensors
-  Safe position monitoring
-  Static valve monitoring
-  Two-hand applications to IIIA and IIIC
-  4-wire switching mats



Set release delay of output Q4 or Q3 and Q4

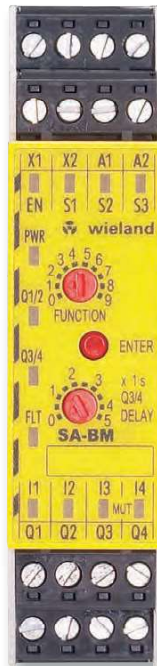

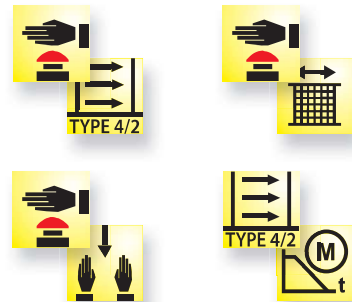
**Example: Combination Functions**



**Example: Dual Functions**



**Example: Special Functions**

-  MAX 5s Jog mode
-  SETUP Setup mode
-  MUTING MUTING and BYPASS



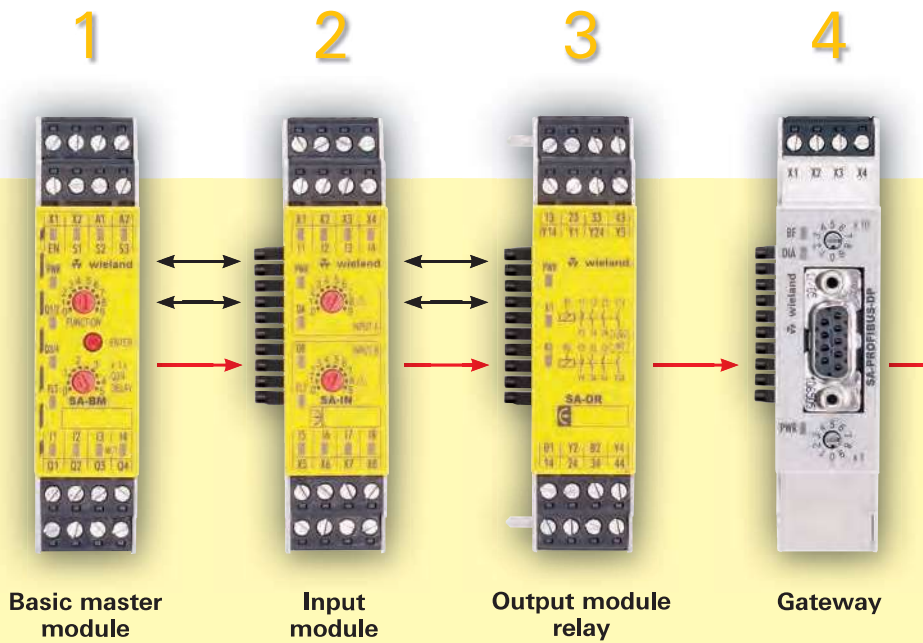

### Modular design

In its maximum configuration **samos®** consists of one basic master module and additional modules to expand function blocks, inputs and outputs.

- Up to **12** safe active modules (input modules)
- Up to **4** additional safe passive output module relays
- **1** additional gateway

- 1 Basic master module**  
Safety module with 9 function blocks, 8 safe inputs and 4 safe outputs (also suitable for stand-alone operation)
- 2 Input module**  
Expansion module with 10 function blocks and 8 safe inputs
- 3 Output module relay**  
Expansion modules with 2 or 4 safe, potential-free relay contacts
- 4 Gateway**  
Fieldbus or Ethernet gateways for easy diagnosis of the **samos®** system

## samos<sup>®</sup> – maximum flexibility

### Intelligently connected modules

The modules are connected to a standard DIN rail and pressed together. Connected on the left of the rail is the Master, the obligatory base module (with coding 1), input modules (coding matches the base module arranged to the left) and relay output modules. All modules in the **samos** overall system are permanently coded and are always permanently assigned to a similarly permanently coded basic module, which eliminates any confusion during service work, for instance.

The relay modules are integrated in the function via external wiring. If necessary such system group are made up of basic modules, input modules and relay output modules can be wired together. This allows the implementation of a wide variety of input/output functions with separate or combined effects.

### Functions with added value

The functions of the basic module and the input modules are set either individually or in combination on the front with 10-position rotary switches (e.g. emergency stop and protective door monitoring with controlled shutdown).

Clear handling – maximum flexibility

### samos<sup>®</sup> modules

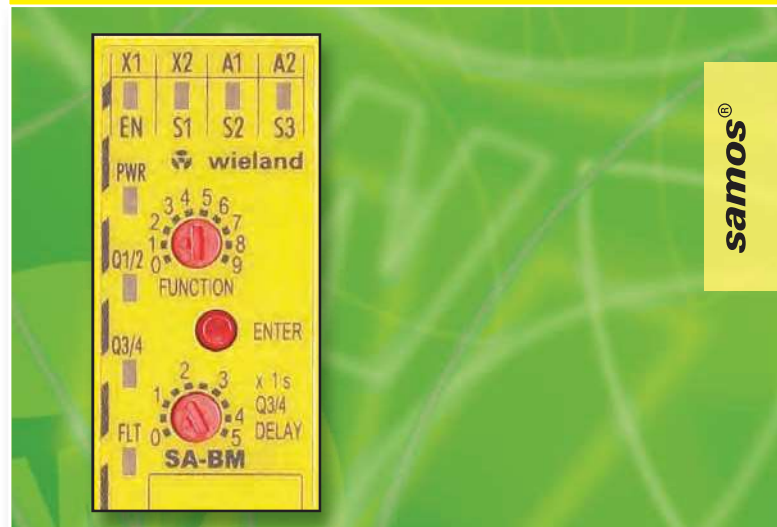

The clear and simple user interface helps to implement safe solutions.

Additional functions such as automatic reset, startup and re-startup blocking or retriggering of the off-delay are implemented with terminal configuration.



# SA-BM – Basic module



## Applications

- Machine building industry
- Combustion plants
- SIL<sub>CL</sub> 3 (EN 62061-1)
- PL e/Category 4 (EN ISO 13849-1)

## Features

- 9 function blocks
- 4 inputs for safety sensors
- 4 safe semiconductor outputs
- Adjustable OFF- delay



## Overview of devices | part numbers

Type	Rated voltage	Terminals	Coding	Part no.	Std. pack
SA-BM-S1-4EKL-A, 5s	24 V DC	Screw terminals, pluggable	1	R1.180.0010.0	1
SA-BM-S1-4EKL-A, 50s	24 V DC	Screw terminals, pluggable	1	R1.180.0020.0	1
SA-BM-S1-4EKL-C, 5s	24 V DC	Push-in terminals, pluggable	1	R1.180.0360.0	1
SA-BM-S1-4EKL-C, 50s	24 V DC	Push-in terminals, pluggable	1	R1.180.0370.0	1

## Technical data

Function display	12 LEDs, green/red
<b>Power supply circuit</b>	
Operating voltage range	19.2 V DC to 30 V DC
Rated consumption	1.8 W
Electrical isolation power supply circuit - control circuit	no
<b>Safe input circuit I1 – I4</b>	
Input voltage range	15 V DC to 30 V DC
Rated current	3 mA
<b>Safe control circuits EN, S1 – S3</b>	
Input voltage range	15 V DC to 30 V DC
Rated current	3 mA
<b>Safe output circuits Q1 – Q4</b>	
Output voltage	24 V DC
Output current I <sub>n</sub> per exit	2 A
<b>Output circuits X1, X2</b>	
Output voltage	24 V DC
Output current I <sub>n</sub> per exit	0.5 A
<b>General technical data</b>	
Protection degree according to DIN 60529 (housing / terminals)	IP40 / IP20
Creepage distances and clearances	EN 60664-1
Ambient temperature / storage temperature	-25°C – +55°C / -25°C – +75°C
Standards	EN 61508, EN 62061, EN ISO 13849-1, EN 50156-1
Approvals	TÜV, cULus

# SA-IN – Input module



## Applications

- Machine building industry
- Combustion plants
- SIL<sub>CL</sub> 3 (EN 62061-1)
- PL e/Category 4 (EN ISO 13849-1)

## Features

- 10 functional modules
- 2 x 4 inputs for sensors
- 2 x 4 test signal outputs

## Overview of devices | part numbers

Type	Rated voltage	Terminals	Coding	Part no.	Std. pack
SA-IN-S1-K-A	24 V DC	Screw terminals, pluggable	1	R1.180.0070.0	1
SA-IN-S1-K-C	24 V DC	Push-in terminals, pluggable	1	R1.180.0420.0	1

## Technical data

Function display	12 LEDs, green/red
<b>Power supply circuit</b>	
Operating voltage range	19.2 V DC to 30 V DC
Rated consumption	1.2 W
Electrical isolation power supply circuit - control circuit	no
<b>Safe input circuit I1 – I8</b>	
Input voltage range	15 V DC to 30 V DC
Rated current	3 mA
<b>Output circuits X1, X8</b>	
Output voltage	24 V DC
Output current I <sub>n</sub> per exit	0.5 A
<b>General technical data</b>	
Protection degree according to DIN 60529 (housing / terminals)	IP40 / IP20
Creepage distances and clearances	EN 60664-1
Ambient temperature / storage temperature	-25°C – +55°C / -25°C – +75°C
Standards	EN 61508, EN 62061, EN ISO 13849-1, EN 50156-1
Approvals	TÜV, cULus

# SA-OR – Output module



## Applications

- Machine building industry
- Combustion plants
- SIL<sub>CL</sub> 3 (EN 62061-1)
- PL e/Category 4 (EN ISO 13849-1)

## Features

- Output module **SA-OR-S1**
  - 2 x 2 safe enabling with switching up to 230 V AC / 6 A
  - 2 x outputs 24 V DC / 50 mA
  - 2 x 1 feedback circuit (NC contact)
- Output module **SA-OR-S2**
  - 1 x 2 safe enabling with switching up to 230 V AC / 6 A
  - 1 x 1 potential-carrying safe output 24 V DC / 50 mA for signaling or safe logical operation
  - 1 x 1 feedback circuit (NC contact)

## Overview of devices | part numbers

Type	Rated voltage	Terminals	Part no.	Std. pack
SA-OR-S1-4RK-A	24 V DC	Screw terminals, pluggable	R1.180.0080.0	1
SA-OR-S2-2RK-A	24 V DC	Screw terminals, pluggable	R1.180.0320.0	1
SA-OR-S1-4RK-C	24 V DC	Push-in terminals, pluggable	R1.180.0430.0	1
SA-OR-S2-2RK-C	24 V DC	Push-in terminals, pluggable	R1.180.0440.0	1

## Technical data

Function display	3 or 2 LEDs, green
<b>Input circuit B1, B2</b>	
Input voltage range	18 V DC to 30 V DC
Electrical isolation power supply circuit – input circuit	no
Electrical isolation input circuit – output circuit	yes
Electrical isolation power supply circuit - output circuit	yes
Rated consumption	2.2 W to 1.1 W
Release delay	30 ms
<b>Output circuits (relays)</b>	
Switching voltage	230 V AC
Output current I <sub>n</sub> per exit	6 A
<b>Output circuits (Y14, Y24)</b>	
Switching voltage	30 V DC
Output current I <sub>n</sub> per exit	75 mA
<b>General technical data</b>	
Protection degree according to DIN 60529 (housing / terminals)	IP40 / IP20
Creepage distances and clearances	EN 60664-1
Ambient temperature / storage temperature	-25°C – +55°C / -25°C – +75°C
Standards	EN 61508, EN 62061, EN ISO 13849-1, EN 50156-1
Approvals	TÜV, cULus

# Gateway

With the **samos®** gateways, system information can be transferred from the configurable **samos®** safety system to an industrial control or a visualization system, for example

### Application examples:

- Input and Output states
- Configuration data
- Fault data (e.g., configuration faults, faults during operation)



### SA-PROFIBUS-DP

#### Features

- Fieldbus protocol PROFIBUS-DP
- Communication with PLC
- Transfer rate up to 12 MBaud
- 4 semi-conductor outputs on board



### SA-DeviceNet

#### Features

- Fieldbus protocol DeviceNet
- Communication with PLC
- Transfer rate up to 500 KBit/s
- 4 semi-conductor outputs on board



### SA-CANopen

#### Features

- Fieldbus protocol CANopen
- Communication with PLC
- Transfer rate up to 1 MBit/s
- 4 semi-conductor outputs on board



## Overview of devices | part numbers

Type	Rated voltage	Terminals	Part no.	Std. pack
SA-CANopen-A	24 V DC	Screw terminals, pluggable	R1.180.0100.0	1
SA-DeviceNet-A	24 V DC	Screw terminals, pluggable	R1.180.0350.0	1
SA-PROFIBUS-DP-A	24 V DC	Screw terminals, pluggable	R1.180.0090.0	1